

Varenummer: 20167V302SW  
 Beskrivelse: E+G  
 Bred fod holder GN167-V30-2-SW

## Mål

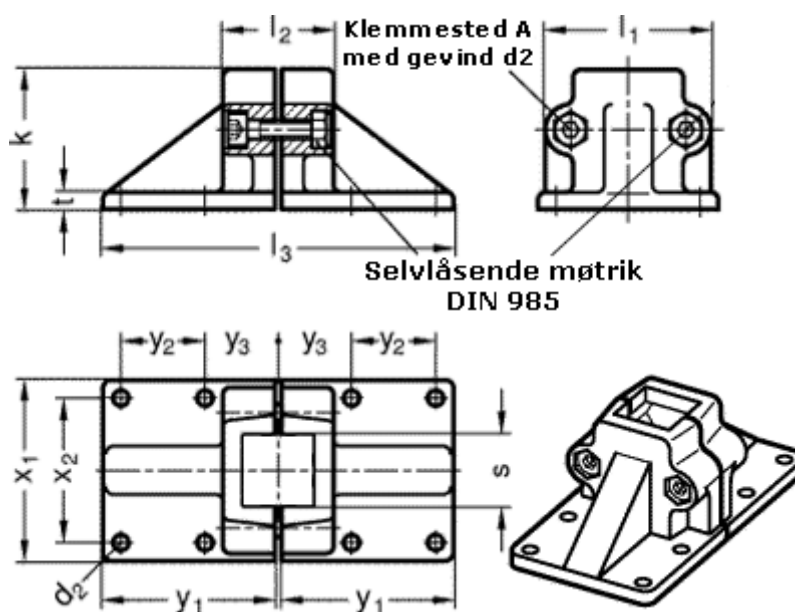

$d2 = 7$	$x1 = 75$
$d3 = M 8$	$x2 = 60$
$k = 58$	$y1 = 72$
$l1 = 69$	$y2 = 35$
$l2 = 46$	$y3 = 30$
$l3 = 146$	
$S = V30$	
$t = 7$	